



Kart Assembly Manual

This manual was developed as a guide to assist High School Karting teams as they prepare their karts for competition in the evGrand Prix Worlds Finals at the Indianapolis Motor Speedway (IMS).

The information provided here is in accordance with several workshops and clinics put on by Top Kart and evGrand Prix Staff. The information contained herein is meant to be a reference tool and not a detailed step by step method for building an electric go kart.

Please be aware that the final authority for kart setup is the Vehicle and Team Equipment Specifications document found on the website evgrandprix.org and all karts will be inspected for compliance to these rules prior to racing in the World Finals event at the Indianapolis Motor Speedway.

See www.evgrandprix.org/parts for links to datasheets, manuals, necessary tools, suppliers, and more. See www.evgrandprix.com/purchasing-guide for a description of necessary tools and equipment for new teams.

Table of Contents

• Fasteners and Tools.....	2
• Seat Mounting.....	4
• Rear Axle Assembly.....	6
• Steering Assembly.....	9
• Powertrain and Brakes.....	15
• Component Arrangement & Kart Balancing.....	22
• Battery Box and Batteries.....	25
• Electronic Assembly & Wiring.....	26
• Bumpers and Guards Assembly.....	33



Fasteners and Tools

Fasteners

Rule 2.3.2.1 in the Vehicle and Team Equipment Specifications document states, “Grade five (5) fasteners, at a minimum, are required for all non-metric screw/bolt type fasteners of .250 inch diameter and larger. A class 8.8 is required for metric fasteners of 6mm and larger. These are similar “medium strength” fasteners. A grade five (5) fastener is indicated by three lines on the head of the cap screw where the lines will be at a 120-degree angle. A class 8.8 is clearly marked as 8.8.”

1. Castle Nut and Cotter Pin – Used to secure each of the front wheels to the axle

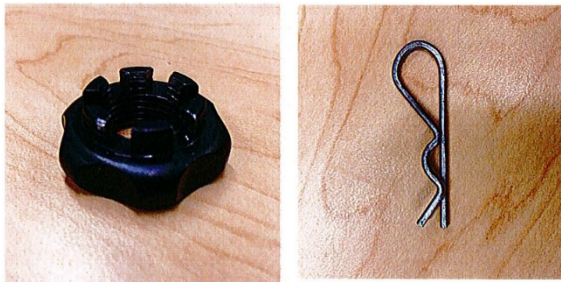

2. Castle Nut and Safety Wire – Used to secure the front wheels, spindle arms, brakes, and powertrain. A hole must be drilled through bolt, wire is inserted and twisted.

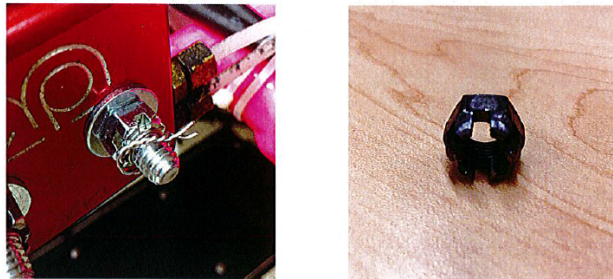

3. Nylon-Fiber Lock Nuts – Used to secure various components to the kart including motor controller, fuse housing, contactor, motor, chain guard, seat, and any other miscellaneous components.





4. Bolt Sizing – When determining what bolt to use for each hole individually, three main things are to be taken into consideration; length, thickness, and threads.
 - **Length:** The bolt should extend longer than the opposite end of the insertion cavity to allow for enough space to secure it at the end with a nut and fastener. You can use measurements to find the desired length.
 - **Thickness:** The selected bolt should also fit in the hole without being too snug. The best way to test this is to actually insert the bolt in order to get a feel for how the fit is.
 - **Threads:** There are many different thread types, but all you need to do is make sure the threads of your chosen bolts match the threads of the corresponding nuts. Metric will have different threading than standard bolts. Standard bolts usually have “course” or “fine” thread options.
5. Washer Details – Washers are used to provide a flat surface for nuts and bolts to tighten against. They also serve as a way to evenly distribute the force from the screw across a larger area. Washers reduce the possibility that a screw or nut will come loose. Lock washers, in particular, exert a force on the nut in order to create a greater frictional force on the threads, which keeps it in place.
 - We use washers between bolt heads and other parts and also between nuts and the parts you are trying to link. There are other situations where you use them as spacers like with the steering linkages.

Tools

6. Box Wrench Set – Used to tighten or loosen a bolt or nut. Various sizes required



7. Socket Wrench Set – Used to tighten or loosen a bolt or nut based on the switch setting. Various socket sizes required. Can be used in tight spaces where a regular wrench may not work easily.



8. Allen Wrench Set – Used to tighten or loosen specific crews and blots. Various sizes required. Hexagonal shaped tool bent to form an “L”.



9. Wire Cutters – Used to cut wire. Caution: cut small ends have a tendency to fly through air upon cutting.





10. Needle-Nose Pliers – Used to twist and secure safety wire.

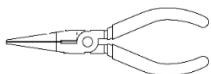

11. Screwdrivers – used to tighten and loosen screws. Flat tipped and Phillips head required. Not meant as a prying tool.

12. Dead Blow Hammer – Used for various purposes including removing front and rear sprockets and replacing the axle.

13. Tape Measure – Used to for cutting proper wires lengths, measuring dimensions of the kart for compliance, and any other time a distance will need to be identified.

Seat Mounting

Summary

When mounting your go-kart seat, into the chassis, please pay close attention to the mounting instructions, which are generally included with the kart manufacturers specifications.

Components

- kart chassis
- Seat

Hardware

- Bolts
- nuts

Tools

- box/socket wrench set
- 24 inch piece of 1x4
- crescent wrench
- 2 C-clamps
- allen wrench set

Instructions

Below are a set of mounting instructions created to help guide you in installing up your seat.

Step 1 – Using crescent wrench, slightly bend seat mounts away from seat area so that seat will fit within the available space without binding on the supports.

Step 2 – Clamp a 1x4 piece of wood to the bottom of the chassis where the seat will be positioned.

Note: If the bottom of the seat will be flush with the bottom of the frame rails, clamp the wood directly to the bottom of the chassis for the seat to rest on. According to rule 2.9.6 in the Rules and Specifications document, no part of the seat may be lower than the lower edge of the kart frame tubing. Be sure to mount your seat no lower than the frame. Resting the seat on the piece of wood during mounting should help.



Step 3 – Measure the distance from the inside of the front most cross bar of the chassis to the lower front portion of the seat. This distance should correspond with the following rules.

Driver Height	Measurement		
	A	B	C
59" – 63"	23-1/4 inches	23-1/2 inches	9-3/8 inches
63" – 67"	23-5/8 inches	23-7/8 inches	9 inches
67" – 71"	24-3/8 inches	24-5/8 inches	7-7/8 inches
71" – 75"	25 inches	25-1/4 inches	8 inches

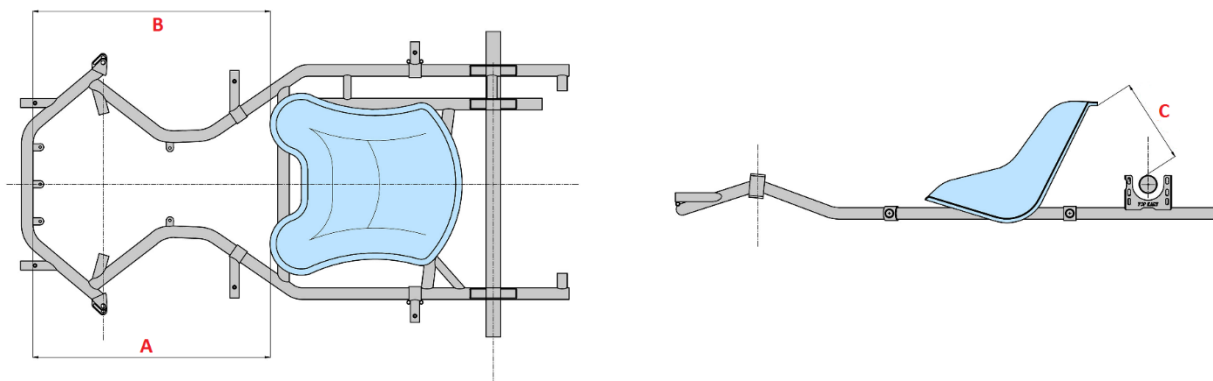

Step 4 – Once the seat is in position, take note of the mounting tabs. You may need to "manipulate" them to run parallel with the surface of the seat. Using a crescent wrench, bend the tabs so that when you tighten the bolt, the seat is not pulled out of shape. This would cause a cracking sound, stressing the seat and pre binding the chassis.

Step 5 – Using a Sharpie, mark the location of the upper support holes onto the seat. This will aid in ensuring seat alignment is maintained when drilling seat for mounting bolts. Ensure that bolt fits into the hole you drilled, but is not overly loose as this can alter seat position.

Step 6 – Tighten upper mounting bolts finger tight, stand back and take a good look at your seat. Make sure it sits square in the kart. Look at it from the front and the back. Once you are satisfied with the position, mark the location of the lower seat mounting holes.

Step 7 – Drill lower seat mounting holes and finger tighten all bolts. You should be able to find the proper spacers for the bottom at this point. Stand back and take a good look at your seat. Make sure it sits square in the kart. Look at it from the front and the back. Once you are satisfied with the position, Remove the piece of wood and tighten all bolts.

Mounting additional Seat Struts – Make sure to sit in the kart before adding your "bolt on" seat struts. Once you are satisfied with the fit, drill and mount your extra seat struts.

Note: Since the driver is the heaviest part on the kart, re-mounting and moving the seat is the most common way to adjust a kart's weight distribution. See Kart Balancing section.



Rear Axle Assembly

Summary

Rear axle assembly requires many fasteners to remain loose during the assembly process. This allows for proper alignment of parts which will enhance the ease of maintenance and repair, should part failure occur. All bolts, nuts, screws and other safety features will require checks for proper tightening and securing prior to each time the kart is run. When aligning the axle, ensure that the bearing is free to adjust to match axle install. Once axle is in place these can be secured and axle will slide in and out of mounting bearings freely.

Important: The axle assembly shows you how to assemble the go-kart rear axle. However, this section can be used for other reasons. One reason knowing how to assemble the axle is important is because of needed maintenance purposes. A go-kart can break down for a variety of reasons and it might be necessary to take the kart apart in order to replace or modify damaged kart components. This set of assembly instruction can thus be used as a guide for how to perform this task in relation to brakes, hub adjustments, and chain alignment to name a few.

WARNING! The Axle you are about to install is commonly known as a “Live Axle.” This means that when the Kart moves, either forward or backward, even if the engine is off and the Kart is merely being pushed, the entire Axle spins. Inherent in this system is a very real danger of any items dangling near the Axle, for example, long hair, clothing, body parts, clothing drawstrings, scarves, shoelaces, etc., may be grabbed by the rotating axle, entangled and then yanked by and/or wrapped around the axle at a rapid rate. **THIS CAN EASILY RESULT IN SEVERE INJURY OR DEATH TO THE KART DRIVER OR BYSTANDERS. NEVER APPROACH OR ALLOW ANYONE ELSE TO APPROACH THE KART WHILE IN POSSESSION OF ITEMS THAT COULD COME INTO CONTACT WITH THE AXLE, INCLUDING NOT ONLY CLOTHING, BUT HAIR, BODY PARTS OR ANY OTHER ITEMS WHICH COULD POSSIBLY BECOME ENTANGLED IN OR MAKE CONTACT WITH THE AXLE IN ANY WAY.** Installation of an axle cover, as explained in a later section of the manual is recommended. **Note:** While the axle cover may lessen the risk of injury, it is neither designed nor guaranteed to fully prevent the live axle spinning to result in entanglement and injury.

Disclaimer: This section includes how the rear axle is assembled for a Top Kart MSTEM EV kart. Images utilized, and accompanying instructions, are for assembly of this particular kart. Most karts have the same type of rear axle assembly. Common variations come from how the axle is mounted to the frame and kart specific sub-assemblies. The karts may have different types of bolts and mountings but will have the same relative locations of where parts are attached, typical variations are included as a reference.



Components

- kart chassis
- axle
- 2 bearings (to match axle)
- 2 bearing cassettes (to match axle)
- brake disc
- brake disc carrier (to match axle)
- sprocket carrier (to match axle)
- 2 rear wheel hubs (to match axle)
- 4 axle keys

Hardware

- Bolts
- nuts

Tools

- box/socket wrench
- extension
- socket
- allen wrench
- mallet

Instructions

Step 1 – Insert bearings into bearing cassettes and finger tighten bolts.

Step 2 – Mount bearing cassettes to outside mounting brackets welded onto frame. Orienting the head of the bearing cassette retaining bolt to the rear of the kart will ease the securing process.

Step 3 – Insert the axle into the bearings, centering the axle with the chassis. Align axle shaft with bearings so that the axle shaft slides into seated bearing freely. Once axle is installed correctly tighten all axle bearing assembly bolts leaving bearing axle set screw loose so that axle can be removed for next steps.

Step 4 – Install brake carrier and disc. Slide the axle from the bearing so that brake disc carrier can be installed. Insert axle key and secure brake carrier in place. Secure brake disc to brake disc carrier. Slide axle back into place

Step 5 – Install sprocket carrier and rear wheel hubs. Slide sprocket carrier onto axle, insert axle key and secure sprocket in place. Insert remaining axle keys to end of axle and slide on rear wheel hubs. Secure in place and tighten all axle bolts, nuts and set screws.



Step 6 – Install brake caliper bracket to left side cassette mounting bracket welded onto kart chassis. Attach calipers to caliper bracket with logo facing up. Note: some adjustment may need to be made to the brake disc carrier to ensure brake caliper/disc alignment is accurate and will function correctly.

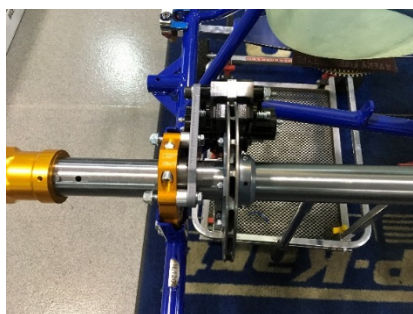

Step 7 – Ensure all nuts, bolts, and set screws are secure. Attach all retaining clips, pins, and wires.

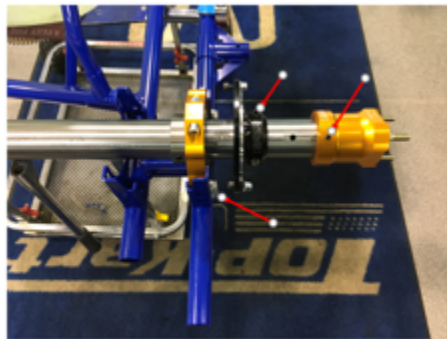
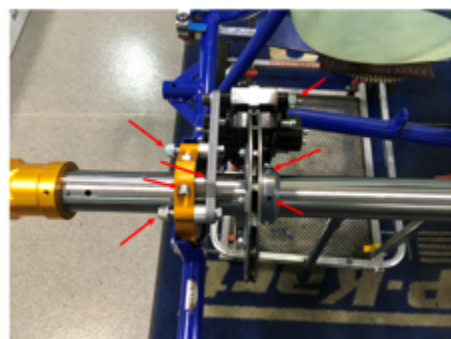

Step 8 – Mount Tires to rear axle hubs and tighten lug nuts.

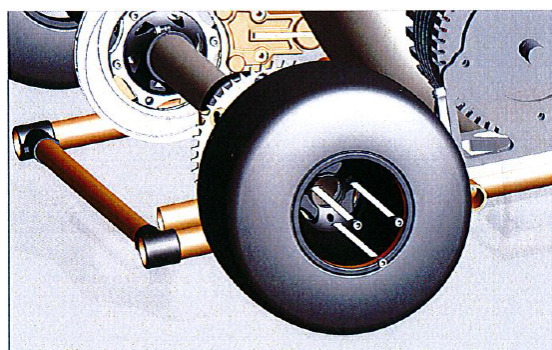



Steering Assembly

Summary

The steering wheel attaches to the steering column, which is attached to the chassis. One end of the tie rods connect to an attachment point on the steering column while the other ends of the tie rods connect to the spindle axle arms. The spindle axles will be bolted to the chassis. Thus, turning the steering wheel pushes and pulls the tie rods, which in turn causes the spindle axles to turn.

Importance: The steering assembly shows you how to assemble the go kart linkage. However, this section can be used for other reasons. One reason knowing how to assemble the steering is important because it is needed for maintenance purposes. A go kart can break down for a variety of reasons and it might be necessary to take the kart apart in order to replace or modify damaged kart components. This assembly manual can thus be used as a guide for how to perform this task.

Disclaimer: This section includes how steering and linkage is assembled for this kart utilized in the images. Most karts have the same type of steering linkage. Common variations in steering come from how the steering rod is mounted to the frame and tie rods are attached to the rod. The karts may have different types of bolts and mountings but will have the same relative locations of where parts are attached.



Steering Column Installation

Steering Column Components

- chassis
- steering wheel
- steering wheel hub
- steering shaft mounting block
- steering shaft

Hardware

- bolts
- nuts
- washers

Tools

- box/socket wrench
- allen wrench
- sockets



Instructions

Step 1 – Attach steering wheel hub to the steering wheel and tighten all bolts.

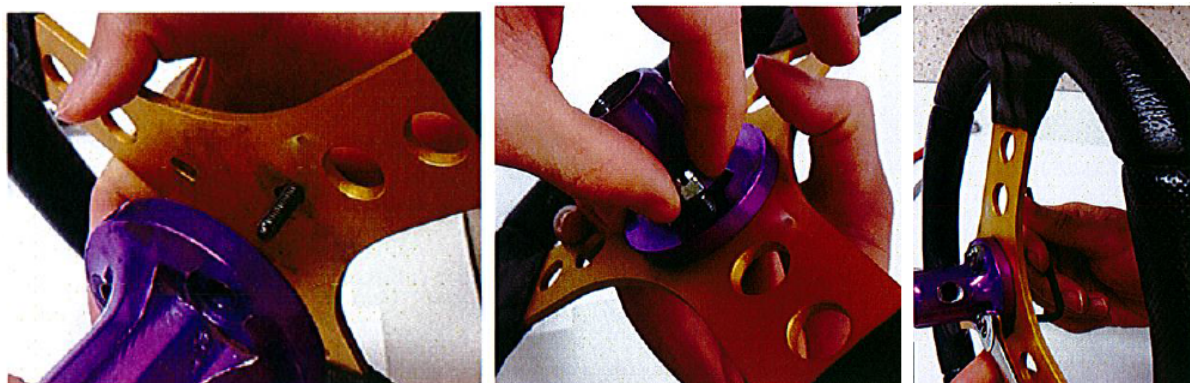

Step 2 – Attach steering column shaft to kart frame. Insert steering column into center slot of frame.



Step 3 – Place castle nut, with top of nut facing down, on protruding end of steering column. Hand tighten the nut.

Step 4 – Rotate steering column so that the tie rod mounting bracket on the lower end of the steering column is oriented toward the floor of the chassis.

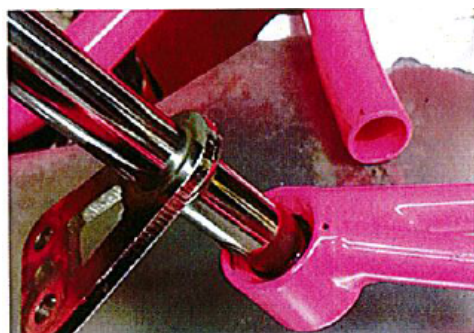

Step 5 – Insert the steering column block onto the steering column. Align holes in steering column support box with holes in the Steering column mounting bracket of the kart chassis.

Step 6 – Insert bolt and spacers. Spacer will be between the frame and steering column block. Tighten bolt.

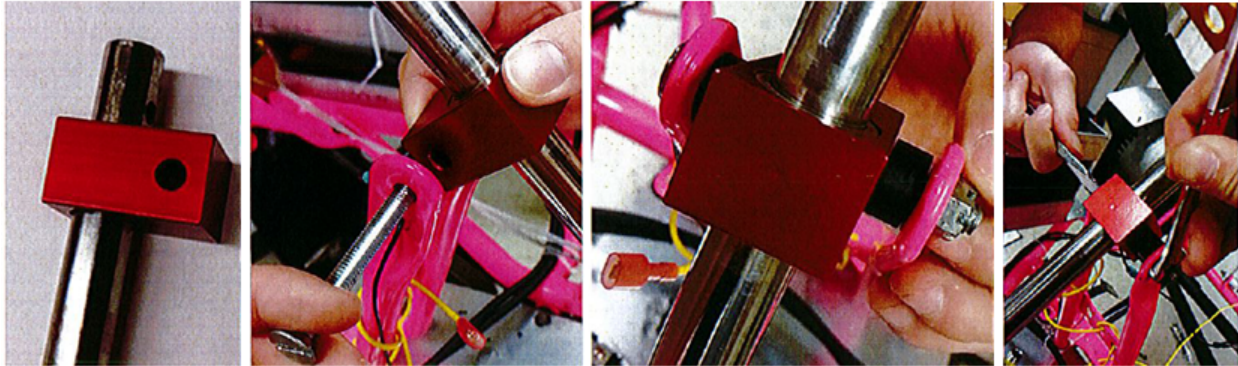

Step 7 – Attach steering wheel to steering column. Place steering wheel onto steering column. Align hole in steering wheel with hole in steering wheel column. Place washer on bolt and insert through steering wheel/shaft and tighten.

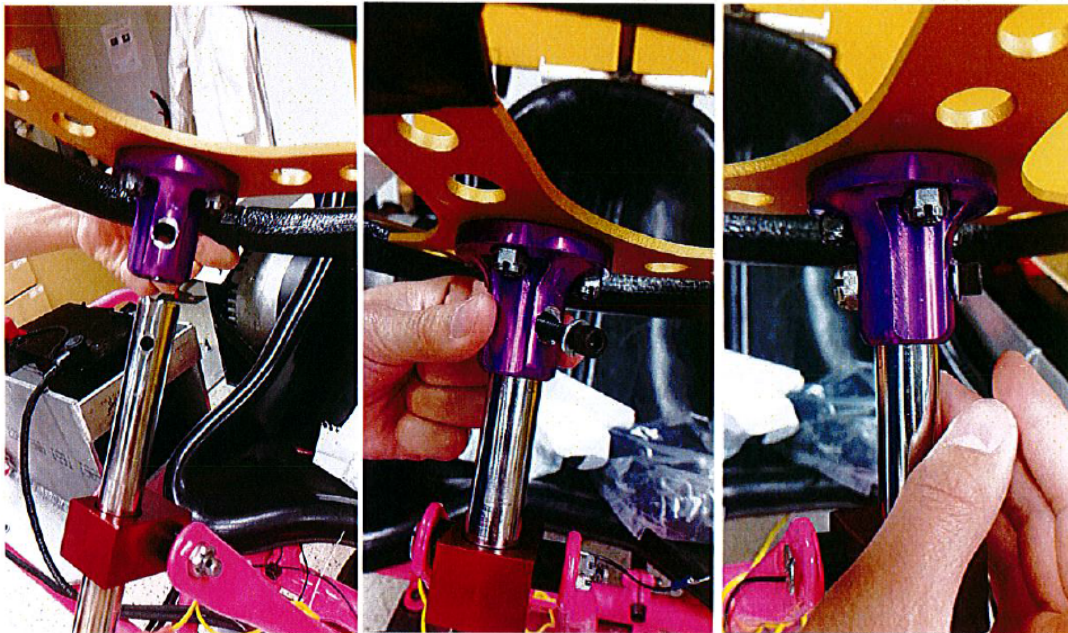

Spindle Installation

Spindle Components

- 2 spindles
- 2 spindle bolts with nuts and washers
- 2 upper pills
- 2 lower pills
- 4 spindle bearings
- spindle spacers (4)
- wheel spacers (various sizes)
- 2 front wheel hubs

Hardware

- bolts
- nuts & washers



Tools

- box/socket wrench,

Instructions

Step 1 – Insert upper and lower pins into “C” shaped spindle mounting brackets welded to each end of the front horizontal chassis member on the left and right sides of the kart chassis.

Step 2 – Start running the spindle bolt through the spindle mounting bracket from the bottom of the spindle bracket of the frame (bolt head facing down). Add spindle spacer.

Step 3 – Insert spindle into mounting bracket so that the spindle arm is pointed towards the backside of the kart. Slide spindle bolt through spindle, add spindle spacer and run the rest of the spindle bolt through other side of mounting bracket.

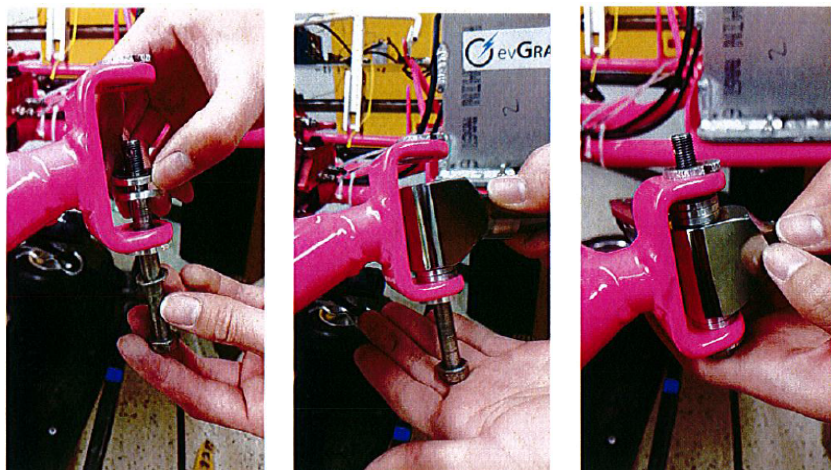

Step 4 – Add washer and castle nut. Tighten spindle bolt. Note: spindle should rotate freely within mounting bracket

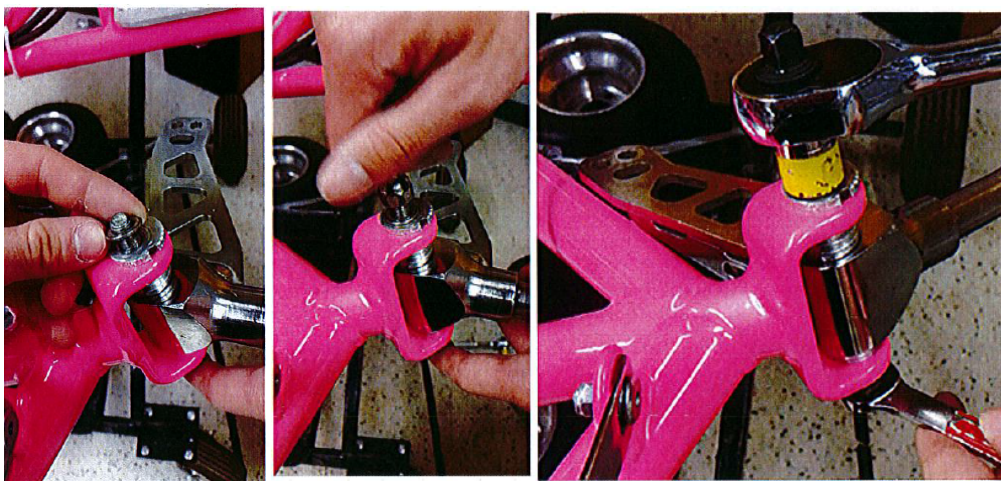

Step 5 – Repeat process for other side of kart.



Alternative mounting instructions.

Spindles Orientation – When properly installed, the stamped dot on Spindles will point up and arms to the rear of the Kart Frame. This will help you to determine proper positioning of “left” and “right” Spindles.

Spindle Bolt Orientation – Spindle bolts may also be inserted from the top of the spindle mounting brackets, through the upper pill then through the spacer spindle second spacer and finally through lower pill. Secure spindle bolt with washer and castle nut on lower side of spindle mounting bracket.



Tie Rod Attachment

Components

- spindle axle
- tie rod
- heim joints
- spacers (as needed)

Hardware

- bolts
- nuts
- washers

Tools

- box/socket wrench,

Instructions

Step 1 – Add a “jam” nut to heim joint. Insert heim joint into tie rod. Adjusting length base on general arrangement of steering components at this point will make attachment of tie rod between spindle and steering column easier.

Step 2 – Attach tie rods to spindle axle. Insert tie rod bolt through heim joint, add spacer, and insert into spindle arm. Add washer and secure with castle.





Step 3 – Attach tie rod to steering column. Insert tie rod bolt through heim joint, add spacer, and insert into tie rod mounting bracket on lower end of steering column. Add washer and secure with castle. Ensure that tie rod mounting bracket is oriented with the holes on the lower end of the steering column pointing toward the floor of the chassis. If needed, rotate the tie rods so that heim joint aligns with holes on steering column.

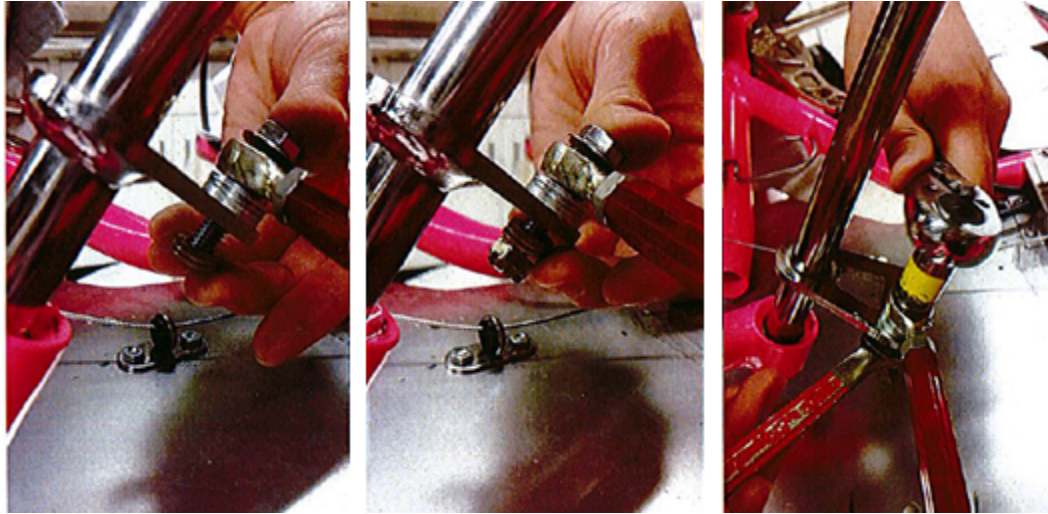

Step 4 – Repeat process for other side of kart.

Step 5 – Mount Tires to spindle axle hubs and tighten castle nuts. Add spindle spacers as needed to balance and set up kart. Typically this will require a variety of spacers placed on spindle prior to mounting of front wheels.

Step 6 – Ensure all nuts, bolts, and set screws are secure. Attach all retaining clips, pins, and wires.





Brakes and Powertrain

Summary

Make sure your tensioner bolt is in and that your drive shaft has a sprocket on it. Assembling brakes will include bleeding brakes and topping off the master cylinder. A brake bleeder will be necessary to complete this step. Powertrain assembly will include attaching the chain to the sprockets. A #35 Chain Break will be necessary to complete this step. When aligning sprockets for chain install, a straight edge tool will be most useful to ensure that sprockets are plumb and square to each other.

Importance: The powertrain and brake assembly shows you how to assemble the go kart braking system and chain driven powertrain. However, this section can be used for other reasons. One important reason for knowing how to assemble the powertrain and brakes is because it is needed for maintenance purposes. A go kart can break down for a variety of reasons and it might be necessary to take the kart apart in order to replace or modify damaged kart components. This assembly manual can thus be used as a guide for how to perform this task in relation to brakes, hub adjustments, and chain alignment to name a few.

Disclaimer: This section includes how the powertrain and brake is assembled for a Top Kart MSTEM EV kart images utilized, and accompanying instructions, are for assembly of this particular kart. Most karts have the same type of powertrain and brake assembly. Common variations come from how the powertrain is mounted to the frame and kart specific sub-assemblies. The karts may have different types of bolts and mountings but will have the same relative locations of where parts are attached, typical variations are included as a reference.

Brake System Installation

Components

- chassis (rear axle assembly installed)
- foot pedals
- master cylinder
- brake calipers
- brake pads
- brake pedal linkage
- brake lines
- brake fluid

Hardware

- Bolts
- Nuts
- washers

Tools

- box/socket wrench
- allen wrench
- pliers



Instructions

Step 1 – Attach foot pedals to chassis mounts at front of kart chassis. Add washer to pedal bolt and insert bolt through pedal mounting bracket welded to front of chassis. Add a spacer to the bolt then add foot pedal, washer and castle nut. Tighten nut until hole in bolt lines up with castle nut grooves. Insert cotter pin or safety wire.



Brake Pedal

Throttle Pedal

Step 2 – Attach master cylinder to chassis mount behind left front tire. Locate master cylinder mounting bracket welded to frame just in front of seat on left hand side of chassis. Bolt master cylinder to mounting bracket and cotter pin or safety wire nuts.



Step 3 – Connect brake pedal to master cylinder using the brake control rod. Attach control rod to master cylinder with retaining pin and secure in place with cotter pin or safety wire. Adjust control rod length and attach to brake pedal with retaining pin and secure in place with cotter pin or safety wire. Master cylinder actuation lever should depress master cylinder plunger when brake pedal is activated.



Note: brake control rods will vary based on manufacturer, however will have similar mounting configurations.



Step 4 – Attach brake caliper to chassis. Loosen brake disc carrier set screw so that brake disc carrier is free of axle. Insert caliper mounting bolts through caliper mounting bracket welded to frame. Orient caliper with brake disc and insert caliper bolts, add washers and castle nuts and secure in place with cotter pins or safety wire. Adjust brake disc carrier so that disc rides freely through calipers and tighten retaining set screws, securing brake disc carrier to axle.



Alternative Caliper Mounting Instructions

Loosen brake disc carrier set screw so that brake disc carrier is free of axle. Attach Caliper mounting bracket to bearing cassette/bearing cassette bracket using bolt, washers, and lock nut. Insert caliper mounting bolts through caliper mounting bracket and complete installation of caliper as indicated above.

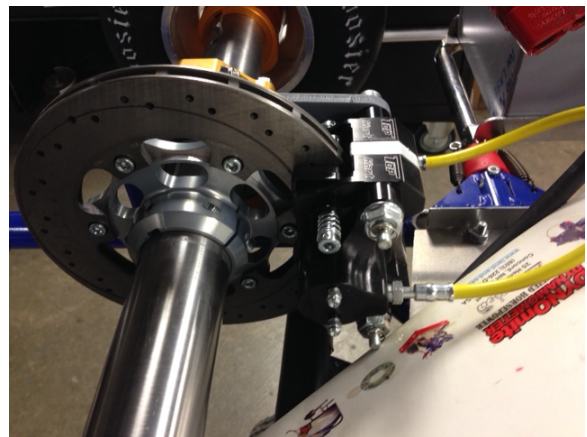
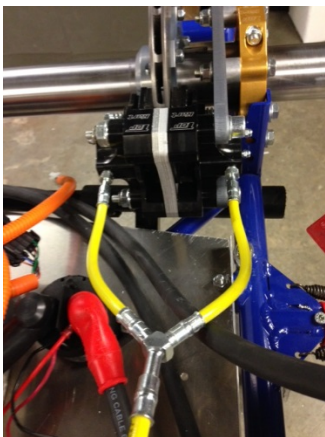



Step 5 – Connect master cylinder to calipers using brake line(s).



Step 6 – Fill master cylinder reservoir with brake fluid and replace cap. Bleed brake line and then refill master cylinder reservoir. **Note:** Adjustment of brake linkage may be required during bleeding of brakes, to ensure proper brake functioning.

NOTE: It may be necessary to bend the Brake Control Rod slightly from its front so that it clears the Frame rail and Seat. Also, you may have to adjust the position of the Brake actuating arm which you may do by loosening the bolt, sliding it off the cam and repositioning on the cam splines.

Powertrain Installation

Components

- Chassis (rear axle assembly installed)
- DC motor (ME0708)
- motor mount
- Rear Sprocket
 - Split type (two halves), 35 chain
 - 55 tooth most common for high school spec motor.
 - Min. tooth: 53 Max tooth: 80+
 - Recommended teams have 5-10 various sizes to tune acceleration & top speed
- Front Sprocket
 - Size: 7/8" shaft diameter. 3/16" keyway. 35 chain
 - 32 tooth most common for high school spec motor.
 - Recommended teams have 2-4 various sizes to tune acceleration & top speed
- Keyway for front drive sprocket (small rectangular piece of metal that transfers torque from motor shaft to front sprocket)



Hardware

- bolts
- nuts
- washers

Tools

- box/socket wrench
- mallet



Instructions

Step 1 – Add a jam nut to motor mount tensioning bolt. Insert tensioning bolt through the bracket welded to the frame, near bearing cassette bracket.

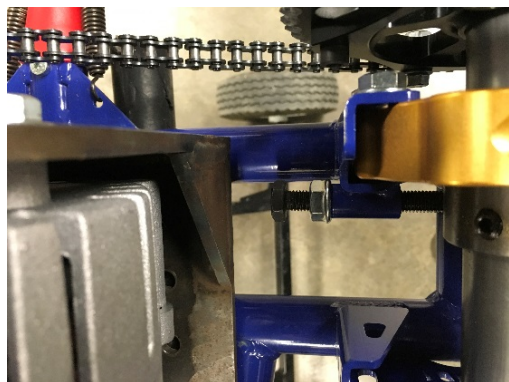

Step 2 – Place top half of motor mounting clamp in desired location on driver's right side of chassis, near rear axle. Attach motor mount mounting clamp to bottom of motor mount by inserting bolt through motor mount then through mounting clamp. Ensure that motor mount is arranged so that motor drive shaft will point away from seat so that axle sprocket and motor sprocket will align. Attach lower half of motor mounting clamp, washer and nut. Finger tighten.



Step 3 – Secure DC motor to motor mount and attach front sprocket to motor drive shaft with keyway.

Step 4 – Attach rear sprocket to sprocket carrier. Loosen sprocket carrier retaining screws so that carrier moves freely around axle.

Step 5 – Align front (drive) sprocket and rear (axle) sprocket so that they run in a straight line from front of kart to rear. Position the Axle Sprocket on the Axle and the Drive sprocket on the motor driveshaft so both sprockets are aligned in the same plane. Note: Position a straight-edge on the tops of both the Drive and Axle Sprockets. Adjust the Drive Sprocket on the motor



driveshaft and the Axle Sprocket on the Axle into positions where they are aligned in exactly the same line/plane. Once correctly positioned, secure the Drive Sprocket to the motor driveshaft by keying it into place and then the Axle Sprocket to the Axle by torquing down the Sprocket/carrier assembly's set screws.

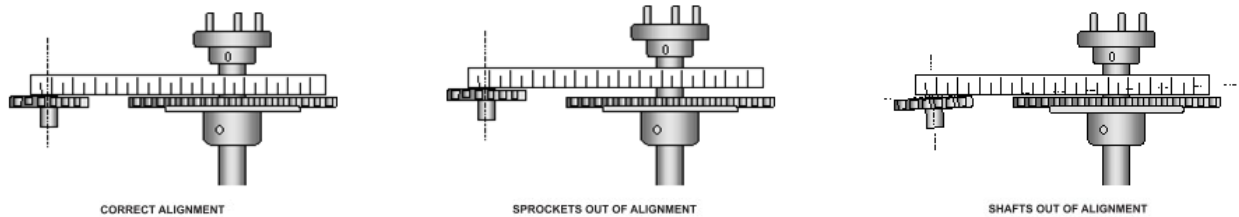

NOTE: True, co-linear/co-planar alignment of the drive sprocket with the rear wheel Sprocket is necessary to prevent excessive Chain wear and dangerous “jumping” of the Chain.

CAUTION: Never run the motor without first installing an adequate and properly installed Chain Deflector.

Step 6 – Measure required chain length and assemble chain to drive sprocket and axle sprocket. Locate the #35 roller Chain and the Connecting Link. Wrap the Chain around the teeth of the drive and axle sprockets forming a closed loop. With a piece of chalk, mark the link where the chain must be “broken.” Using a chain-breaker, cut the Chain at the marked link. Once sized correctly, re-wrap the Chain around both Sprockets and complete the Chain loop by securing it with the Connecting Link.



NOTE: The closed end of the Connecting Link's spring clip should point in the direction the Chain advances during operation.



Step 7 – Carefully slide the motor forward on the motor mounting plate until the Chain is SNUG, BUT NOT TIGHT. If the chain is too tight, it will be more prone to popping off or breaking. A good rule of thumb is to have the chain loose enough to around 0.5 to 1 inch vertically (up and down). Take special care not to allow the motor to slip sideways as this will ruin the Sprocket alignment. Adjust tensioner to desired chain tension and secure all nuts and bolts.

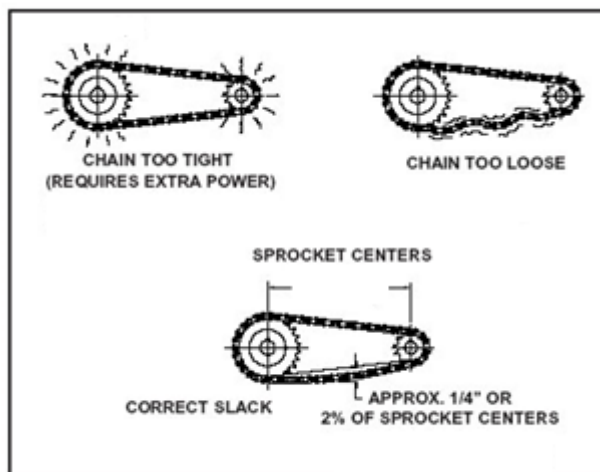

Step 8 – After the engine is in its forward, “chain-snug” position, make certain the drive and axle sprockets are exactly aligned and then secure the engine in place by tightly torquing down the motor mounting hardware.

NOTE: If the sprockets sneak out of alignment, leave the motor in its forward, chain-snug position and realign the sprockets.

Step 9 – Install chain guard. A chain guard/deflector is designed to help prevent a broken chain, or one that has “jumped” off its sprockets, from flying out and away from the kart and causing injury to the Kart driver or bystanders by “deflecting” it to the ground. As a result, a chain deflector is required at all times during any operation of the motor or Kart. Position and install the chain deflector onto the motor. You can make your own guard or purchase one as seen in this picture.

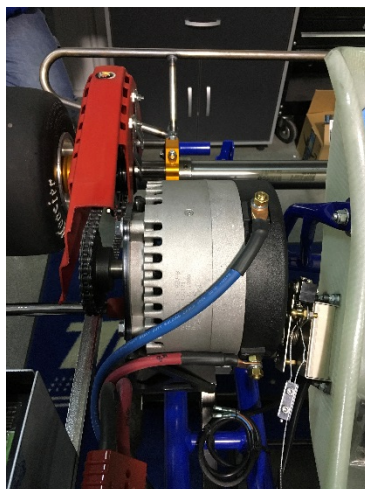



Note: A chain deflector IS NOT designed to, and is unlikely to, prevent items from coming into contact with or becoming entangled in the Chain or Sprockets. Examples: long scarves, long hair, baggy clothing, shoelaces, fingers or other body parts, etc.—generally, any item which could possibly dangle into the area of chain operation. Such entanglements could cause serious injury or death. **NEVER USE, WEAR OR CARRY ANY ITEMS WHICH MIGHT POSSIBLY BECOME SO ENTANGLED NOR PLACE ANY PART OF YOUR BODY CLOSE TO CHAIN AND/OR SPROCKET.**

Component Arrangement and Kart Balancing

Summary:

The kart still needs to have all the electrical components and the front and rear bumper installed. However, these components need to be arranged around the kart in a manner that will promote a balance and center of gravity within the kart for optimal racing conditions. All components going onto the kart from this point forward should be arranged to facilitate the following weight distributions.

- Ideal front weight distribution 43.0%
- Ideal rear weight distribution 57%
- Ideal side to side weight distribution 50/50%

Your kart will need to need to be assembled in a manner that will make this possible once the build is complete. The following settings are recommended as a starting point for establishing a basic kart setup and balance prior to installation of remaining kart components.

- Weight distribution should be 43.0% front, 57% rear and 50/50% side to side.
- Front toe should be set out to 1/16" to 1/8" (1-3mm). For hard compound tires, set toe out at 1/8" to 1/4" (3-6mm).
- Caster/Camber adjusters at front spindles should be set at II top & II bottom.
- Front width should be 45-1/2" to 46".
- Seat should be at standard mounting points.
- Rear wheel hubs should be medium length.
- Rear ride height should be as low as possible.
- Rear track should be set just below the legal limit of 55 and 1/8 inches. A good starting point would be 54-3/4" for most applications.
- Axle should be the medium stiffness.
- Tire pressure should be 9-10 psi (measured cold)



Disclaimer: Images of the frame in this manual are used for example purposes and may not reflect current chassis specifications in the Vehicle and Team Equipment Specifications document. Be aware that Rule 2.4.1 states that “... Nerf bars are a required part of the race vehicle frame. NO aluminum base frames will be allowed in the competition. All Parts of the race vehicle must clear the ground by one (1) Inch at all times...”

Though photos will share many characteristics actual kart chassis will vary slightly and should be taken into account.

Components

- chassis (seat, rear axle, spindle and steering, and motor assemblies installed)
- base plate
- batteries
- battery boxes
- nerf bars
- front bumper hardware
- rear bumper hardware
- motor controller

Hardware

- Bolts
- Nuts
- washers

Tools

- box/socket wrench
- allen wrench
- drill
- drill bits
- pliers

Instructions

Base Plate Installation

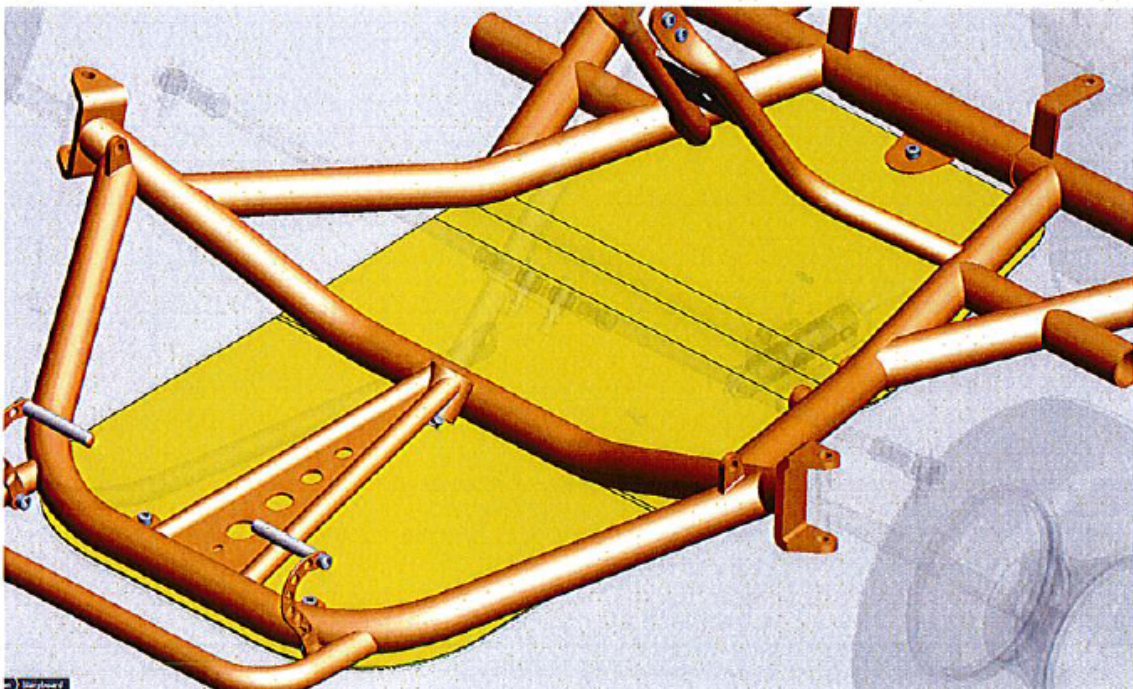



NOTE: When you are mounting the base plate or other components to the kart, **be sure to install the bolts with their heads facing the ground and bolts extending up toward the sky.** This allows the excess bolt length to not scrape the ground if it was installed vice-versa.

Step 1 – Look on the frame and find the mounting holes for the base plate as shown in the picture above.

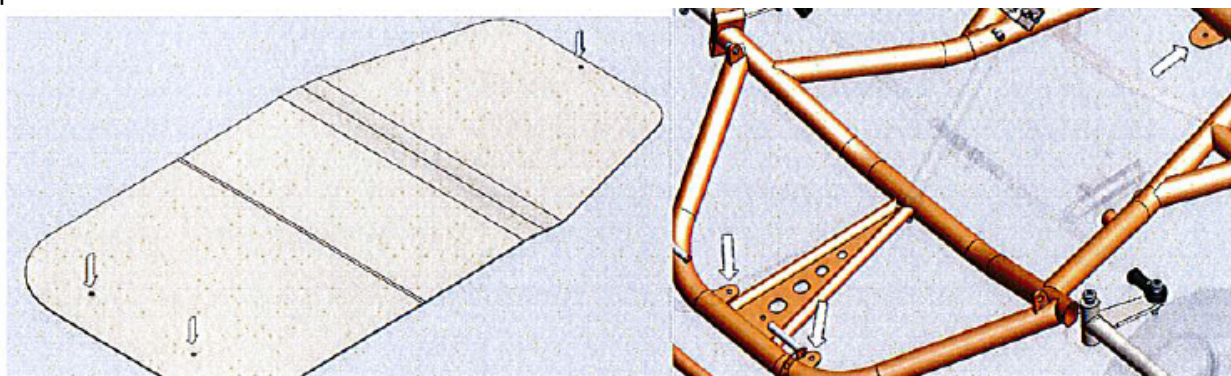

Step 2 – Align the holes on the base plate with the corresponding holes on the frame. The base plate goes below the mounting brackets. **Note:** The order from the top side is – nut, washer, frame, base plate, bolt head.

Step 3 – Insert the bolt in that order, the head should be on the bottom of the base plate and pass through both the base plate and the frame

Step 4 – Tighten the nut using the appropriate wrench and allen wrench. Repeat process for remaining bolts

Component Installation

Step 1 – Set kart on 4 bathroom scales. Each scale should be on a single bathroom scale. Determine the weight of the front of the kart by adding the reading of the front scales together. Determine the weight of the rear of the kart by adding the rear scales together. Determine the total weight of the kart by adding the front weight and the rear weight. Calculate the percent of weight in the front of the kart and the percent of weight in the rear of the kart.

$$\left(\frac{\text{front}}{\text{total}} \right) 100 = \text{Percent} \quad \text{This value should be 43-45\%}$$

$$\left(\frac{\text{rear}}{\text{total}} \right) 100 = \text{Percent} \quad \text{This value should be 55-57\%}$$



Step 2 – Determine the weight of the left side of the kart by adding the reading of the scales on the left side of the kart together. Determine the weight of the right of the kart by adding the scales on the right side of the kart together. Calculate the percent of weight from side to side of the kart.

$$\left(\frac{\textit{left}}{\textit{total}}\right)100 = \textit{Percent} \quad \text{This value should be 48-52\%}$$

$$\left(\frac{\textit{right}}{\textit{total}}\right)100 = \textit{Percent} \quad \text{This value should be 48-52\%}$$

Step 3 – With kart on scales, have the “driver” sit in the seat of the kart and repeat steps 1 and 2.

Step 4 – With “driver still sitting in the seat, arrange the remaining components (nerf bars, battery boxes, batteries, motor controller, front and rear bumper hardware) of the kart in a manner that establishes a front to rear weight ratio of 43% to 57% as closely as possible. **Note:** this value does not have to be exact however, care should be taken to ensure that the ratio at least 45% to 55% respectively.

Step 5 – Secure battery boxes, motor controller, front and rear bumper hardware, and nerf bars in place.

Battery Box Mounting and Battery Installation

Step 1 – Insert Batteries into battery boxes in accordance with established kart balancing requirements

Step 2 – Connect all 4 lead acid batteries in series using the high current (larger) cable. Be careful as you do this as your wrench may accidentally short the pack if you hit the handle to another terminal while tightening.

- The cables that come in your Top Kart Wiring Kit require the pack be wired in a specific manner. All karts are recommended to have the battery packs most negative point will be to the drivers left, farthest forward, and the farthest left (outside terminal).
- A high current cable (green if ordered from Top Kart) is used as the mid-pack voltage that connects the right side battery pack negative (-) terminal with the left side battery pack positive (+). This cable should go across your kart, under the front of the seat and on top of the chassis.
- Ensure that the cable extend beyond the battery box. This cable will be receive terminal connectors and be attached to the batteries during Electrical Assembly
- A second high current cable (black if ordered from Top Kart) is used to connect the left side battery pack negative (-) terminal with an Anderson 175 amp connector on the right side battery pack. This cable should also go across your kart, under the front of the seat and on top of the chassis.



- Ensure that the cable extend beyond the battery box. This cable will be receive a terminal connector and Anderson connector during Electrical Assembly

See Battery Current Path section on www.evgrandprix.org/circuits for a video description.

Electronics Assembly and Wiring

Summary

Components including the connector, contactor, fuse, shunt resistor, emergency stop, and controller must first be bolted to the metal electronics plate located on the back of the kart before being wired to one another. Next, the throttle must be bolted to the floorboard and the pedal to the frame before connecting the two components. The final step includes placing and wiring the batteries in order to provide power to the system.

Important: The electrical assembly can help one grasp a basic understanding of how the system works. This not only empowers that person to be able to make small modifications to this section of the assembly, but also helps that person's ability to troubleshoot given the possibility that problems may occur on the track.

Disclaimer: This section describes and illustrates how to add necessary electronic components to the overall kart and how to wire them to one another. There are many possible outcomes as to how one can assemble this section as long as the desired variation abides by the requirements set forth in the Vehicle and Team Equipment Specifications document, and provides a power source to the kart. Please note that most welding cables and wires must be crimped and have ring terminals at each end. Easy-to-follow directions for stripping, crimping, and applying a ring terminal to a wire can be on www.evgrandprix.org/crimping. Also note that if holes required in the assembly are not predrilled, you must drill them yourself. Review some instructional videos and pro-tips at www.evgrandprix.org/drilling.

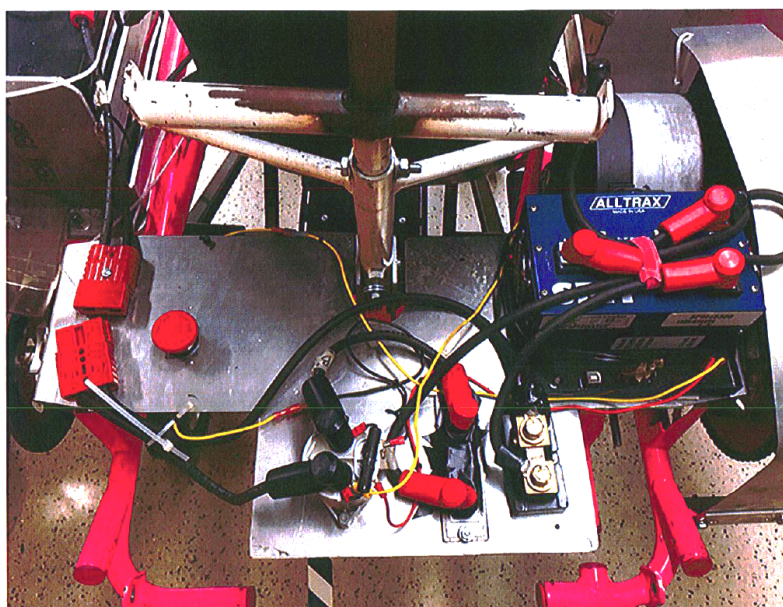



Components

- Lead Acid Batteries – (Rule 2.6.1 “...High School series may **only use Interstate SLA1155 or SLA1156 (12v, 35Ah) lead acid based battery chemistries.**” SLA1155 should be the preferred version.
- Battery Charger – Check to see if there is a spec/required charger for the year you are racing. If not, you may source one yourself or reach out to ej.evgrandprix@gmail.com to purchase one.
- Motor – Rule 2.6.12 “The MotoEnergy ME0708 PMDC brushed DC motor is the spec motor for the high school series.”



- Motor Controller – Rule 2.7.2 “The Alltrax SPM 48300 is the required controller.” However this component is being replaced by the Alltrax SR 48300 which will also be allowed. They have the same specs and performance capability. Also your kart is limited by the PEM to 10kW (14kW for collegiate), so there is no benefit to higher power controllers/motors.

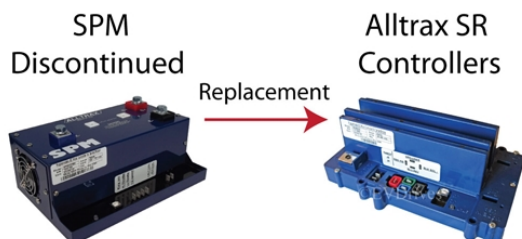

- Throttle Potentiometer

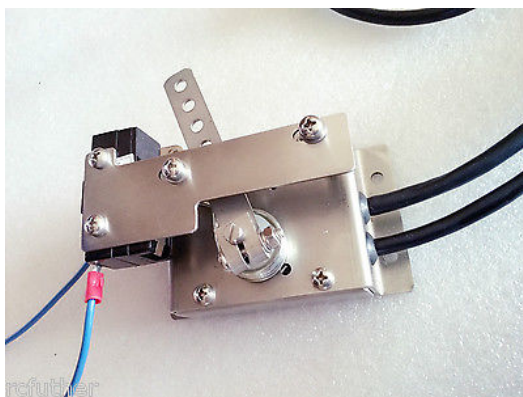



- Contactor/Relay (Tyoc LEV-200 48-volt relay. LEV200A6NAA)



- 250 amp, 48 Volt Fuse assembly



- Anderson SB-175 Connector – 2 Required – Rule 2.6.11.1 “The PEM must remain visible at all times on the top of the battery boxes and a 6”x14”x8” area is needed for the box. The PEM will be connected using Anderson 175amp Red style connectors.” Note that the Red connector will not connect with other colored SB175 connectors.



- Pre-charged Resistor



- Emergency Stop

Top



Bottom

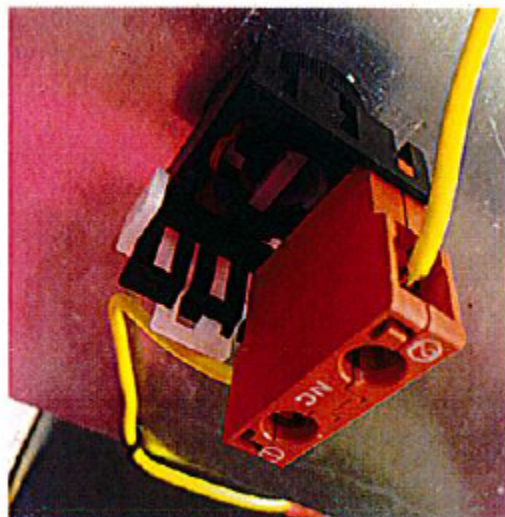



Hardware

- bolts
- nuts
- washers
- zip ties
- electrical tape
- wire connectors

Tools

- box/socket wrench
- extension
- socket
- allen wrench
- mallet
- wire - cutter/crimper/stripper

Instructions

Powertrain High Current: *If you decide to purchase the top Kart Wiring Kit the cables described here will come as a complete wiring harness. This harness will work if placement of motor controller, contactor and fuse are on the floor pan in front of the driver seat.*

Step 1 – Determine a location for placement of the 250 amp, 48 volt fuse assembly and secure in place.

Step 2 – Measure the distance from the 250 amp, 48 V fuse assembly to the PEM/Physics Box mounting location, on right side battery box. Add 6 inches to this measurement and cut a red high current cable to this length. Attach the red high current cable, just cut, to the 250 amp, 48V fuse assembly and the Anderson 175 amp connector to the other end of this cable. **Note:** The fuse assembly does not have any terminals as the bare wire is inserted into the assembly and the bolt is tightened down. **Tip:** Be sure to mount the fuse assembly with its bolts first, before inserting and tightening the wire. You will not be able to access mounting bolts/nuts when wire is inserted. Fuse comes separately and must be installed in the housing.

Step 3 – Determine a location for the Contactor (LEV-200 24-volt relay) and secure in place.

Step 4 – Measure the distance from the 250 amp, 48 V fuse assembly to the contactor. Add 6 inches to this measurement and cut a red high current cable to this length. Connect one end of this cable to the 250 amp, 48 V fuse assembly and then run cable to the (+) high current terminal of the contactor attach a terminal connector to the cable and attach to contactor. **Note:** The contactor has 4 terminals. 2 high current and 2 coil terminals. Use the high current wire with the larger, high current terminals.

Step 5 – Attach the pre-charge resistor from the positive (+) high current terminal on the contactor to the negative (-) high current terminal on the contactor. **Note:** The purpose of this resistor is to allow a low-current “pre-charge” of the large capacitors in the motor controller. If this is not there, there would be an in-rush of current when contactor closes and could damage the contactor. The motor controller will likely throw an error or not work if no pre-charge resistor is present.

Step 6 – Measure the distance from the contactor to the motor controller. Add 6 inches to this measurement and cut a red high current cable to this length. Add a terminal connector to each end of this cable. Attach one end of this cable to the high current negative (-) terminal on the contactor. Run cable from the high current negative (-) terminal of the contactor to the B+



terminal of the motor controller and attach terminal connector to the motor controller. **Note:** Also connecting to this B+ terminal is the cable that runs from your motor controller B+ terminal to one of the two terminals on your motor.

Step 7 – Measure the distance from the motor controller to the motor. Add 6 inches to this measurement and cut a red high current cable to this length. Add a terminal connector to each end of this cable. Connect one end of this cable to the B+ terminal of the motor controller. Run the cable to the motor and connect the other end of this cable one of the two terminals on your motor. **Note:** It does not matter which terminal you connect this red (+) wire to on the motor as all that determines is the direction the motor spins. Once you get your kart's wheels spinning, if the wheels are going the wrong direction, you can simply switch the terminals on the motor to change direction.

Step 8 – Measure the distance from the motor to the motor controller. Add 6 inches to this measurement and cut a black high current cable to this length. Add a terminal connector to each end of this cable. Connect one end of this high current wire to the other motor terminal and run it to your motor controller. Connect this end of the cable to the M- terminal of the motor controller.

Step 9 – Measure the distance from the motor controller to the PEM/Physics Box mounting location, on right side battery box. Add 6 inches to this measurement and cut a black high current cable to this length. Add a terminal connector to each end of this cable. Connect one end of this cable to the B- terminal of the motor controller. Run the cable to the PEM/Physics Box mounting location and connect to the Anderson 175 amp connector from step 1.

See Powetrain High Current section on www.evgrandprix.org/circuits for a video description.

Key Switch Ignition (KSI): *This circuit is what tells the motor controller to “turn on” or close/activate the contactor. When the contactor closes, the battery pack is now connected to the powertrain motor controller/motor and can operate the kart. Note: If you purchase the Top Kart Wiring Kit, you will likely need to create the wires for this circuit yourself as your kit may not come with this. But it is very easy to create. All wiring for KSI will be with smaller, lower current wire. 22-28 gauge wire should work.*

You will need ring terminals, a wire stripper, and a wire crimper in order to make these wires.

Step 1 – Mount a toggle switch to the steering wheel. Measure the distance from the 250 amp, 48 V fuse to the toggle switch mounted on the steering wheel. Add 6 inches to this measurement and cut a 22-28 gauge wire to this length. Connect one end of this wire to the 250 amp, 48 V fuse. Run the wire to the toggle on the steering wheel. Connect this end of the wire to the toggle switch on the steering wheel. **Important:** You need to grab battery pack voltage (48v) to start this circuit. **Note:** You must start this KSI circuit somewhere before the contactor high current (-) terminal. This can be the contactor high current (+) terminal or either of the fuse terminals. This is because the contactor is open/deactivated at first and requires 48v from KSI in order to close (and subsequently apply 48v to the system), but KSI can't apply 48v if it's voltage supply relies on the contactor being closed/active. It's a catch 22.



Step 2 – Measure the distance from the toggle switch mounted on the steering wheel to the KSI connector on the motor controller. Add 6 inches to this measurement and cut a 22-28 gauge wire to this length. Connect one end of this wire to the toggle switch mounted on the steering wheel. Run the wire to the motor controller. Connect this end of the wire to the KSI pin of the motor controller. **Note:** Be sure all your crimps for the low current wire are good. This means after attaching a new ring terminal to a wire, give it a strong pull to see if the wire can pull out. **This is the most common reason a kart stops working on the track:** a wire is pulled out of a crimp. If your wire is too small for your crimp (meaning the crimp doesn't squeeze the wire enough), try stripping the wire two or three times longer and folding the bare wire over on itself. This doubles or triples the gauge.

See KSI Circuit section on www.evgrandprix.org/circuits for a video description.

Coil Circuit: This is probably the most complex circuit as it strings throughout the whole kart. What it does is go from the motor controller to the contactor in order to activate it's coil and "turn on" or close the contactor. But we also wire-in an emergency E-Stop into this circuit as well. **Important:** One inevitable issue teams will run into is thinking their kart isn't working for various reasons, but really the E-Stop is pressed in. Be sure the E-Stop pulled out and not pressed.

Step 1 – Mount E-Stop Kill Switch to the kart. Measure the distance from the contactor to the E-Stop Kill Switch. Add 6 inches to this measurement and cut a 22-28 gauge wire to this length. Connect one end of this wire to the contactor. Run the wire to the E-Stop Kill Switch. Connect this end to the E-Stop Kill Switch. **Note:** if you purchased the Top Kart Wiring Harness, your harness will contain low current wires coming out of the wiring harness at certain points. This is for the contactor circuit.

Step 2 – Measure the distance from the E-Stop Kill Switch to the motor controller Coil (+) terminal. Add 6 inches to this measurement and cut a 22-28 gauge wire to this length. Connect one end of this wire to the E-Stop Kill Switch. Run the wire to the motor controller. Connect this end of the wire to the Coil (+) pin of the motor controller.

Step 3 – Measure the distance from the motor controller Coil (-) to the contactor. Add 6 inches to this measurement and cut a 22-28 gauge wire to this length. Connect on end of this wire to the motor controller Coil (-) pin. Run the wire to the contactor. Connect this end of the wire to the contactor. **Note:** If you purchased the Top Kart Wiring Harness you will notice two sections of the wiring harness that break out from the harness. Each section has two low current wires in it. The section that ends in disconnects (non-ring terminals) will go to your motor controller coil pins. The section that ends in ring terminals will go to your contactor pins. **Important:** The two red wires that break out from the harness is what you will use to go to the E-Stop. One of these red wires will have a fuse installed. You will need to make and connect your low-current wire to these wires. Then take your low-current wire and run it to wherever you installed your E-Stop. When connecting to your E-Stop, make sure you connect it to pins that are meant to go together. I believe A+ would pair with A-, and B+ with B-. You can use a multimeter's continuity function to check which pins are connected.



You should now have your coil circuit wired.

See Coil Circuit section on www.evgrandprix.org/circuits for a video description.

Throttle Control The throttle control has two sets of wires leading from it. One set of wires will be used for connecting the throttle control to the motor controller and the second set will be left disconnected. More about this second set of throttle control wires will be addressed in the Physics Box Manual.

Step 1 – Determine a location for mounting the Throttle Control to the kart and secure in place. This will vary from team to team. Some prefer to mount it under the steering column, some in front of the battery pack on the right side, some prefer to mount it on the seat near the motor terminals.

Step 2 – Be sure the throttle cable runs smoothly from throttle pedal to the throttle potentiometer. You may need to cut and adjust the aircraft cable length. Make sure the pedal has its own counter-springs as well as the throttle potentiometer having its own counter spring. Also make sure the pedal and potentiometer both travel enough between no throttle and full throttle foot position (be sure there's "enough play" in the throttle). The more play, the more resolution/control you have over the throttle (instead of 0-100% throttle with little foot displacement).

Step 3 – Connect the brown wire to the "Hi Throttle" pin on the motor controller. Connect the blue wire to the "Lo Throttle" pin on the motor controller. If you connect the wrong wires, there should not be any damage. You will likely see the motor controller throwing an error or the throttle simply won't work.

Step 4 – Once you have your programmer plugged into the kart and have your wheels spinning, use the throttle reading on the program to make sure your full throttle position with the drivers foot is actually commanding 100% throttle in the program. If it is not, you will only never hit your full throttle and think your kart is under-powered. You can adjust the throttle map so that 100% throttle command takes place with the drivers foot at a lesser (or greater) throttle foot position.

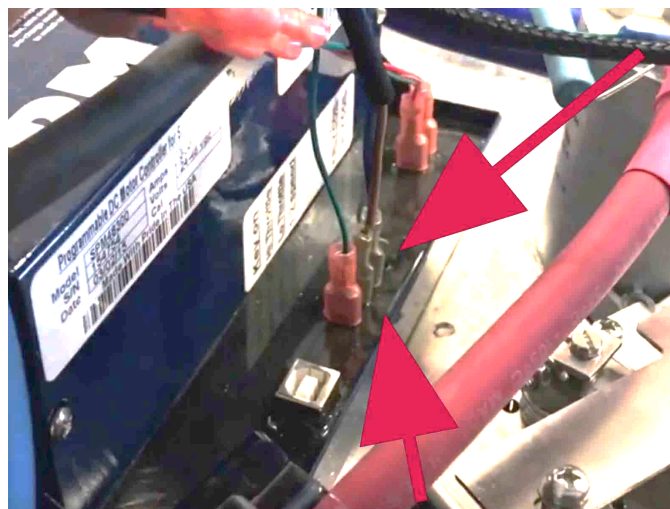



Bumpers and Guards Assembly

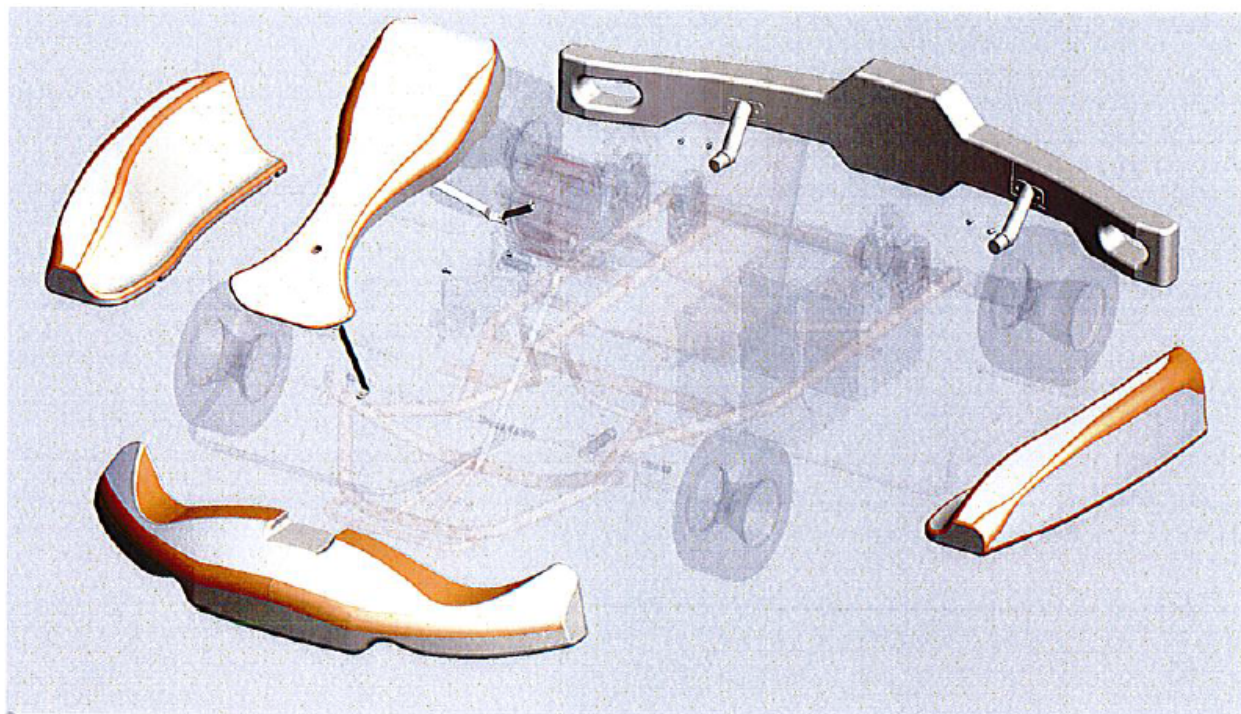

Summary:

The front, back, and side bumpers are attached to the frame via clamps. The steering wheel fairing is attached to the frame via a clamp and is screwed in connection to the front bumper. The bumpers provide protection for the driver during a race and protect vital components of the kart. The frame itself holds all of the components together.

Disclaimer: Images of the frame in this manual are used for example purposes and may not reflect current chassis specifications in the Vehicle and Team Equipment Specifications document. Be aware that Rule 2.4.1 states that “Teams must race with a Top Kart chassis as described in specification 2.1. Nerf bars are a required part of the race vehicle frame. All Parts of the race vehicle must clear the ground by one (1) Inch at all times...”

Though photos will share many characteristics actual kart chassis will vary slightly and should be taken into account.

Components

- front bumper
- back bumper
- steering wheel fairing
- side bumpers (optional)

Hardware

- bolts
- nuts
- washers
- spacers
- clamps



Tools

- box/socket wrench
- sockets
- allen wrench

Instructions

Step 1 – Secure the molded plastic front bumper to the metal bumper hoop. Attach the bumper clamps to the metal bumper hoop. After making sure the clamps are secure, attach the bumper to the front of the go kart using the protrusions present on the back of the bumper.

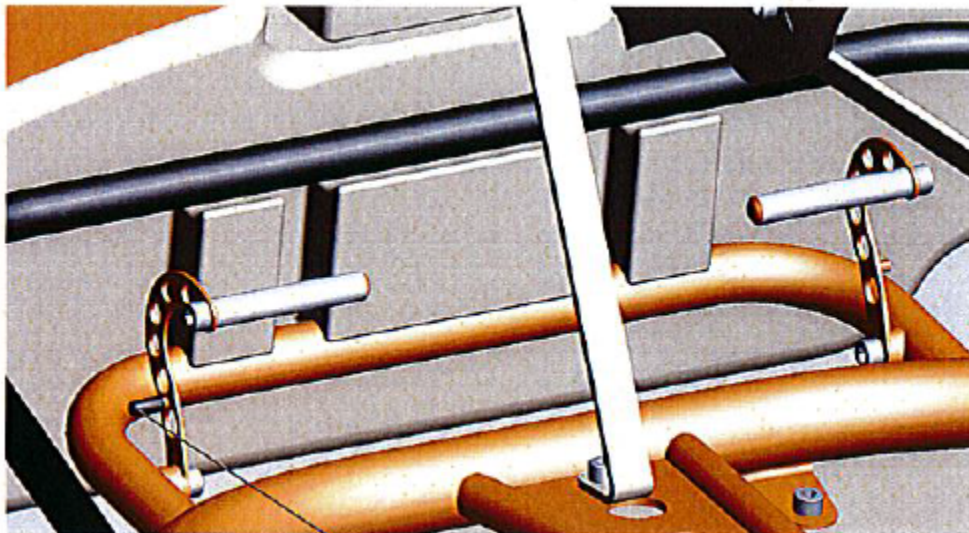

Step 2 – Secure the molded plastic rear bumper to the rear bumper hardware. To fix more securely, put the bolts through the back bumper into the slots available on the metal frame and screw on 2 nuts and a washer to each bolt or the order shown in the diagram.

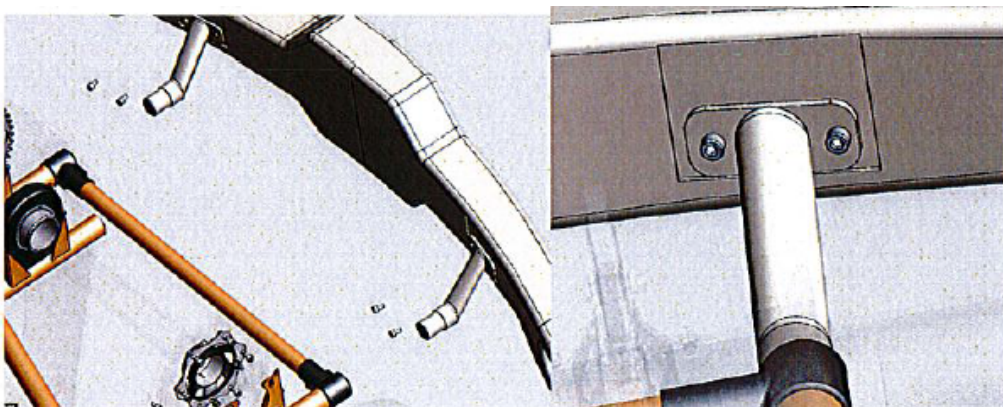

Step 3 – Attach the steering fairing strut (metal bar which extends to connect frame to steering wheel fairing) to the frame via a bolt. Attach the upper strut to the steering shaft via another bolt. The steering bumper should rest on the top of the front bumper. See image associated with (1) above.



Step 4 – Left and Right Bumpers (Optional) – For the left and right bumpers, attach them to the nerf bars.

